

iHome®



iBT210

***Bluetooth Wireless
Dual Alarm Clock***



instruction manual

Questions? Contact Customer Service at 1-800-288-2792

iBT210

Introduction

Thank you for purchasing the iHome iBT210. This product is designed to provide high quality wireless sound for your iPad, iPhone, iPod or other Bluetooth audio device.

This instruction booklet explains the basic operation and care of the unit. Please read it carefully and keep for future reference.

Maintenance

- Place the unit on a level surface away from sources of direct sunlight or excessive heat.
- Protect your furniture when placing your unit on a natural wood and lacquered finish. A cloth or other protective material should be placed between it and the furniture.
- Clean your unit with a soft cloth moistened only with mild soap and water. Stronger cleaning agents, such as thinner or similar materials can damage the surface of the unit.

Table of Contents

| | |
|--|-----|
| What's Included | 3 |
| Meet Your iBT210 | 4 |
| The Display/Setting Up the Unit | 5 |
| Replacing and Installing Clock Backup Batteries | 6 |
| Setting the Clock/Setting and Using the Alarms | 7-8 |
| Previewing the Alarm and Turning the Alarm On/Off | 8 |
| Snooze/Display Dimmer Button/Sleep Mode/FM Radio | 9 |
| Setting and Using FM Presets/Using FM Radio in Other Countries | 10 |
| Pairing Your Bluetooth Device | 11 |
| Playing Audio Via Bluetooth..... | 12 |
| Using the Speakerphone Feature | 12 |
| Playing Audio via Aux-In | 13 |
| Charging Devices via USB Port..... | 14 |
| Battery Use Cautions and Tips | 15 |
| Consumer Product Safety Guide..... | 16 |
| FCC Information..... | 17 |
| Troubleshooting | 18 |
| Warranty..... | 19 |

iBT210

Included

- iBT210 Alarm Clock
- 100V-240V universal AC adaptor
- 2 AA batteries



iBT210 alarm clock

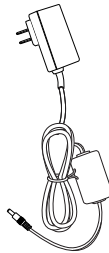

power
adaptor

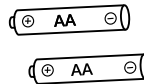

2 AA batteries

iBT210

Meet Your iBT210

Top

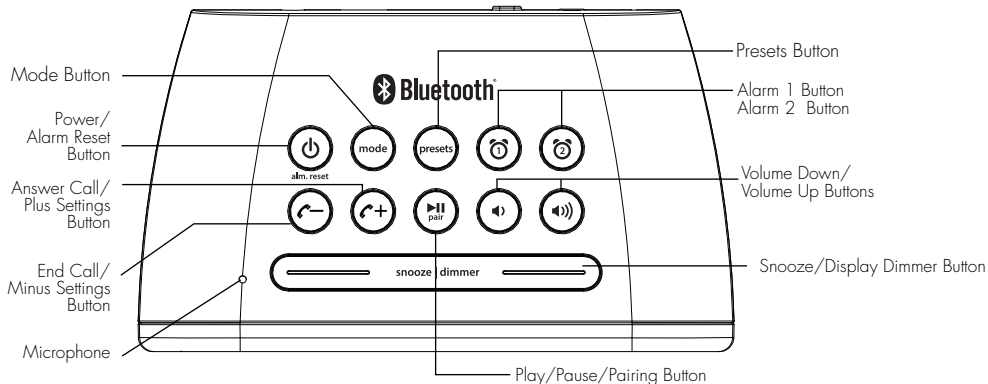

Bottom

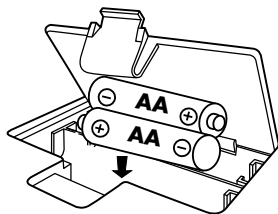

Backup Battery Compartment

Back

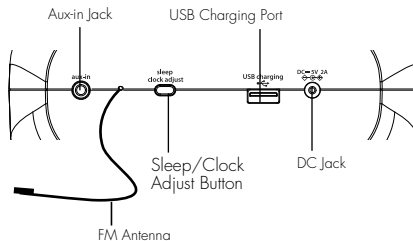

Using the iBT210

The Display

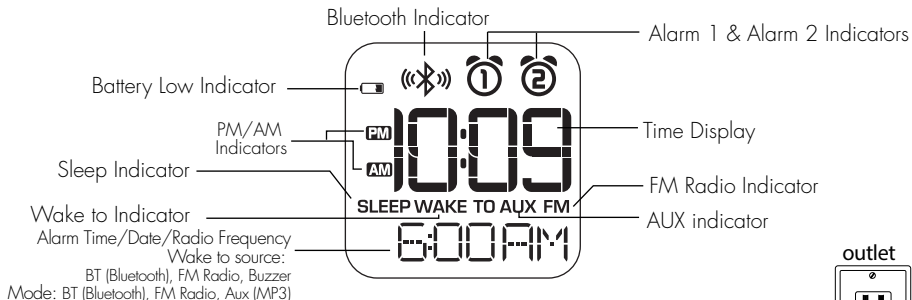

Setting Up the Unit

Connect the included AC adaptor to the DC jack located on the back of the unit and connect the other end to a working wall outlet. Extend FM antenna.

Turning the Unit ON and OFF*

1. Once the AC adaptor is properly connected, press the **Power Button** located on top of the unit to turn the unit ON. "ON" will appear briefly on the display.
2. Press the **Power Button** to turn the unit OFF. "OFF" will appear briefly on the display.

*NOTE: The unit has an automatic shut off function: if no audio is detected for 15 minutes, the unit will power off.

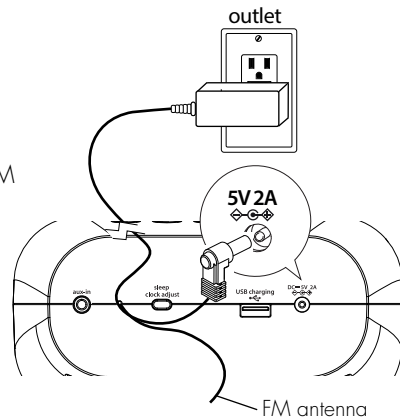

Using the iBT210

Replacing and Installing Clock Backup Batteries

Note: 2 AA batteries are included with the unit. Install them before using the unit.

This model is equipped with a battery backup circuit that will maintain the time and alarm time settings in the event of a temporary power interruption (the display is NOT lit). The battery backup circuit will also operate the buzzer alarm to wake you up at the selected wake up time even if the power is out. When the backup batteries are getting weak the Low Backup Battery Indicator will begin flashing in the display. When you see this flashing indicator you should replace the backup batteries as soon as possible. Note: We recommend alkaline batteries for best performance.

To install/replace the backup batteries:

IMPORTANT: When replacing the backup batteries be sure to have the unit connected to the AC outlet to maintain all of your settings, otherwise it will be necessary to reset the time and alarm time after the batteries are replaced.

1. Press tab to remove the battery door located on the bottom of the unit. If replacing batteries, remove the exhausted batteries.
2. Insert 2 fresh AA batteries in the backup battery compartment. Make sure the polarity of the batteries ("+" or "-" nodes) matches the illustration.
3. Close the battery compartment door. Confirm that the backup battery indicator is not flashing in the display.

Note: Make sure you dispose of batteries properly (see your local regulations)

Replacing Backup Battery

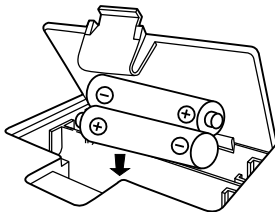

Using the iBT210

Setting the Clock

1. Press and hold the **Sleep/Clock Adjust Button** located on the back of the unit for 2 seconds until the clock display flashes and a beep sounds.
2. Press the **←** or **→** Buttons to adjust the clock to the current time (hold for rapid setting). Make sure you set the correct AM/PM time. The AM and PM indicators appear to the left of the display.
3. Press the **Sleep/Clock Adjust Button** to confirm the time. The year will flash on the display.
4. Press the **←** or **→** Buttons to adjust the clock to the current year (hold for rapid setting).
5. Press the **Sleep/Clock Adjust Button** to confirm the year. The date and month will flash on the display.
6. Press the **←** or **→** Buttons to adjust the clock to the current date and month (hold for rapid setting).
7. Press the **Sleep/Clock Adjust Button** to confirm the date and month and exit clock setting mode. 2 beeps will confirm clock setting is complete.

TIP: To toggle the clock display between standard 12 hour time and 24 hour ("military") time display, press the **Alarm Button** or **Alarm Button** while the display is flashing during clock setting.

Setting and Using the Alarms

This unit features dual alarms which can be set to different times and alarm sources. Each is set in the same way. Instructions are given as "Alarm Button"; use **Alarm Button** or **Alarm Button** to set respective alarms.

Note: Each step must be completed while display is flashing or step will time-out with any changes saved.

Setting and Using the Alarms (Continued)

1. Press and hold the **Alarm Button** for 2 seconds until the alarm time display and alarm icon flash. A beep sounds.
2. Press the **←** or **→** **Buttons** to adjust the alarm time to the desired time (hold for rapid setting). Make sure you set the correct AM/PM alarm time. The AM and PM indicators appear to the right of the alarm time display.
3. Press the **Alarm Button** to confirm the alarm time setting. The **wake-to** source will flash.
4. Press the **←** or **→** **Buttons** to select the desired wake to alarm source: Bluetooth, radio or buzzer.
Wake to Bluetooth: You will wake to the currently linked Bluetooth device. If no device is detected, the alarm will default to buzzer.
Wake to Radio: Press the **Alarm Button** to confirm. Press the **Presets Button** to select FM preset to wake to, or press the **←** or **→** **Buttons** to tune in a desired wake to station. (To set Presets, see Setting and Using FM Presets on page 10.)
Wake to Buzzer: You will wake to buzzer.
5. Press the **Alarm Button** to confirm the alarm settings and exit alarm setting mode. 2 beeps will confirm alarm setting is complete. The alarm icon will remain on the display, indicating the alarm is armed.
6. At the set time, the alarm will sound for 60 minutes. To turn off a sounding alarm and reset it to come on the next day at the same time, press the **Power/Alarm Reset Button** or the associated alarm button (**⏻** or **⏻**) to reset alarm.

Turning the Alarm On/Off

Press and release the desired **Alarm Button** as needed to toggle the alarm ON (indicated by the alarm icon) or OFF (no alarm icon).

Using the iBT210

Snooze/Display Dimmer Button

1. The default snooze time is 9 minutes. To adjust Snooze duration, press and hold the **Snooze/Display Dimmer Button** during normal operation (when no alarm is sounding).
2. Press the **←** or **→** **Buttons** to select the desired snooze time (between 01 and 29 minutes).
3. Press and release the **Snooze/Display Dimmer Button** to confirm Snooze setting. 2 beeps will sound.
4. While the alarm is sounding, press and release the **Snooze/Display Dimmer Button** to temporarily silence the alarm for the set duration. Snooze can be used several times during the 60 minute alarm cycle.
5. To adjust the brightness of the display, press and release the **Snooze/Display Dimmer Button** during normal operation (when no alarm is sounding) to cycle through the brightness display settings.

Sleep Mode

This unit allows you to sleep to the current sound source for a set time before turning the unit off.

1. To set Sleep time, press and release the **Sleep/Clock Adjust Button** as needed to cycle to the desired sleep duration: 120, 90, 60, 30 or 15 minutes or OFF (turns the unit off).
2. Press the **⏮** or **⏭** **Buttons** to adjust the sleep volume on the unit. Note that the sleep volume setting is stored separately from other volume settings.

FM Radio

Extend the FM antenna for best reception.

1. Press and release the **Mode Button** as needed until the FM indicator icon and current FM radio frequency appear on the display.
2. Press the **←** or **→** **Buttons** to tune the radio to the desired station (hold to scan for the next clear station).
3. Press the **⏮** or **⏭** **Buttons** to adjust the volume on the unit.
4. When you are through listening, press the **⏻ Power/Alarm Reset Button** to turn the unit off.



Using the iBT210

Setting and Using FM Presets

The unit allows you to store up to 6 FM radio station presets

1. Press and release the **Mode Button** as needed until the FM indicator icon appears on the display.
2. Press and release the **Presets Button** as needed until the preset number (P1- P6) you wish to set is displayed, then *press and hold* the **Presets Button** to enter setting mode.
3. Press the **↶** or **↷** **Buttons** to tune the radio to the desired station (hold to scan for the next clear station).
4. Press and release the **Presets Button**. 2 beeps will sound to confirm the preset has been assigned. Repeat steps 2 - 4 until you have set up to 6 preset stations.
5. To listen to a preset FM station at any time, follow steps 1 - 2 to turn on FM radio mode and cycle to the desired preset.

Using FM Radio in Other Countries

Different areas of the world use different FM frequency steps and ranges. By default, this unit is set to USA frequency steps. To use the radio outside the USA:

1. Make sure unit is OFF.
2. Press and hold the **Mode Button** until "USA" appears in the display.
3. Press and release **↶** or **↷** **Buttons** to cycle to your location: Europe, Japan, Australia, China or USA.
4. Press the **Mode Button** again to exit frequency setting mode. 2 beeps will confirm setting.

Using the iBT210

Pairing Your Bluetooth Device

The first time the unit is powered on, it will automatically enter pairing mode for 3 minutes. Turn on your Bluetooth device and make it “discoverable” by turning on Bluetooth mode (check in Options or Settings). Select “iHome iBT210” on the device’s Bluetooth menu to connect. To pair manually at other times, follow the steps below.

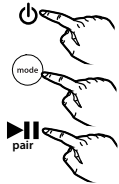

1. Turn on your Bluetooth device and make it “discoverable” by turning on Bluetooth mode (check in Options or Settings).
2. Press the **Power/Alarm Reset Button** to turn the unit ON.
3. Press and release the **Mode Button** as needed until “BT” appears on the display.
4. Press and hold the **Play/Pause/Pairing Button** for 2 seconds. The iBT210 will beep and BT and the Bluetooth  icon will flash on the display, indicating the iBT210 is in pairing mode.

5. “iHome iBT210” should appear in your device’s Bluetooth menu. Select “iHome iBT210” to connect it. If prompted for a passcode, enter “1234” on your device’s keypad.

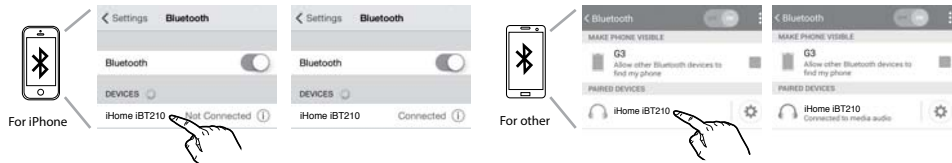

6. If pairing is successful, PAIR will appear at the bottom of the display, the Bluetooth icon  will appear solid and 2 beeps will sound, indicating the iBT210 is ready to play music. There should also be an indication on your device. If no device is successfully paired within 3 minutes the iBT210 will default to previous mode. In the future, when unit is ON and in Bluetooth mode, the iBT210 will attempt to autolink to a previously paired device when the device is within range (about 33 feet).

Using the iBT210

Playing Audio via Bluetooth

1. Press the **Power/Alarm Reset Button** to turn the unit ON.
2. Press and release the **Mode Button** as needed until "BT" appears on the display.
3. Press the **▶|| Play/Pause/Pairing Button** on the unit to play audio from your linked Bluetooth device.
4. Press the **⏮** or **⏭** **Buttons** to go to the previous or next track.
5. Press the **🔊** or **🔇** **Buttons** to adjust the volume on the unit. You may need to adjust the volume on your device, too.
6. When done listening, press the **⏻ Power/Alarm Reset Button** to turn the unit off.

Using the Speakerphone feature

NOTE: The unit must be powered on and linked to a Bluetooth phone to receive a call.

1. When a call is received, playing music is muted to hear the ring tone. "CALL" will flash on the display. Adjust call volume on your device and/or on the unit as needed. Press the **⏭** **Button** to answer the call; *press and hold* the **⏮** **Button** to ignore the call. For call waiting function, press the **⏭** **Button** to place a currently active call on hold and answer a new call; press the **⏭** **Button** to switch between the calls.
2. When a call is completed, press the **⏮** **Button** to end the call and resume previous function.

Using the iBT210

Playing Audio via Aux-In

1. Connect one end of a standard audio cable (not included) into the aux-in jack on the back of the unit and the other end into the headphone or output jack of your audio device.
2. Press the **Power/Alarm Reset Button** on the unit to turn it on.
3. Press and release the **Mode Button** as needed until the AUX indicator icon and “MP3” appear on the display.
4. Place your audio device in play mode. Navigate tracks and adjust output volume on the device.
5. Press the **Volume Up** or **Volume Down** **Buttons** to adjust the volume on the unit. You need to adjust the volume on your device as well.
6. When done listening, press the **Power/Alarm Reset Button** to turn the unit off. Remember to turn off your audio device, too.

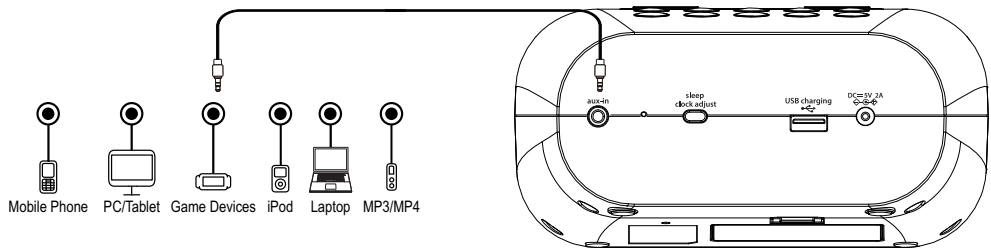

Using the iBT210

Charging Devices via USB Port

1. Connect the standard size end of a USB cable (not included) to the USB Port on back of the unit and connect the other end to the charging port on your device. It's often best to use the charging cable supplied with your device.
2. Monitor the charging on your device. Some devices use a proprietary charging method and will not charge using the USB Port. If this happens, you must charge your device using the charger that came with it.

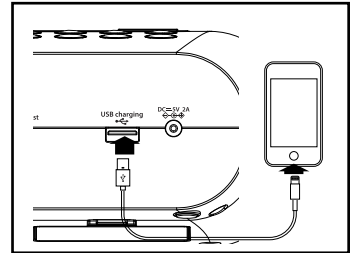

NOTE: Unit must be plugged into working outlet to charge devices

Using the iBT210

Battery Use Cautions and Tips

- Only use the recommended/supplied batteries or equivalent
- Use alkaline batteries for longer life
- Do not mix old and new batteries, and do not mix alkaline, carbon-zinc or rechargeable nickel-cadmium batteries
- Insert batteries with proper polarity (+/-) as indicated
- Remove exhausted batteries from product
- Recharge rechargeable batteries under adult supervision
- Do not attempt to recharge non-rechargeable batteries
- Do not open batteries or heat them beyond normal ambient temperatures.
- To prevent battery leakage or damage remove batteries from a product if it will not be used for a month or longer.
- Use extreme caution handling leaking batteries (avoid direct contact with eyes and skin). If battery leakage comes in contact with eyes, IMMEDIATELY flush the eye with lukewarm and gently flowing water for at least 30 minutes. If skin contact occurs, wash skin with clear water for at least 15 minutes. Seek medical attention if any symptoms occur.
- Store in cool, dry, ventilated area away from hazardous or combustible material.
- Do not dispose of batteries in the household trash or fire
- Follow applicable laws and local regulations for the disposal and transportation of batteries.

Consumer Product Safety Guide

IMPORTANT SAFETY INSTRUCTIONS

When used in the directed manner, this unit has been designed and manufactured to ensure your personal safety. However, improper use can result in potential electrical shock or fire hazards. Please read all safety and operating instructions carefully before installation and use, and keep these instructions handy for future reference. Take special note of all warnings listed in these instructions and on the unit.

1. **Water and Moisture** – The unit should not be used near water. For example: near a bathtub, washbowl, kitchen sink, laundry tub, swimming pool or in a wet basement.
2. **Ventilation** – The unit should be situated so that its location or position does not interfere with its proper ventilation. For example, it should not be situated on a bed, sofa, rug or similar surface that may block ventilation openings. Also, it should not be placed in a built-in installation, such as a bookcase or cabinet, which may impede the flow of air through the ventilation openings.
3. **Heat** – The unit should be situated away from heat sources such as radiators, heat registers, stoves or other appliances (including amplifiers) that produce heat.
4. **Power Sources** – The unit should be connected to a power supply only of the type described in the operating instructions or as marked on the appliance. Only use the AC adapter that came with the unit.
5. **Power-Cable Protection** – Power supply cables should be routed so that they are not likely to be walked on or pinched by items placed upon or against them. It is always best to have a clear area from where the cable exits the unit to where it is plugged into an AC socket.
6. **Cleaning** – The unit should be cleaned only using a warm damp cloth. Do not use solvents, etc.
7. **Objects and Liquid Entry** – Care should be taken so that objects do not fall and liquids are not spilled into any openings or vents located on the product.
8. **Attachments** – Do not use attachments not recommended by the product manufacturer.
9. **Lightning and Power Surge Protection** – Unplug the unit from the wall socket and disconnect the antenna or cable system during a lightning storm or when it is left unattended and unused for long periods of time. This will prevent damage to the product due to lightning and power-line surges.
10. **Overloading** – Do not overload wall sockets, extension cords, or integral convenience receptacles as this can result in a risk of fire or electric shock.
11. **Damage Requiring Service** – The unit should be serviced by qualified service personnel when:
 - A. the power supply cable or plug has been damaged.
 - B. objects have fallen into or liquid has been spilled into the enclosure.
 - C. the unit has been exposed to rain.
 - D. the unit has been dropped or the enclosure damaged.
 - E. the unit exhibits a marked change in performance or does not operate normally.
12. **Antenna** – Do not connect an external antenna to the unit (other than that provided).
13. **Periods of Nonuse** – If the unit is to be left unused for an extended period of time, such as a month or longer, the backup batteries should be removed from the unit to prevent damage or corrosion.
14. **Servicing** – The user should not attempt to service the unit beyond those methods described in the user's operating instructions. Service methods not covered in the operating instructions should be referred to qualified service personnel.

FCC Information

iBT210

FCC ID: EMOIBT210

IC: 986B-IBT210

FCC Radiation Exposure Statement

This equipment complies with FCC RF radiation exposure limits set forth for an uncontrolled environment.

This device complies with Part 15 of the FCC Rules, operation is subject to the following two conditions: (1) This device may not cause harmful interference, and (2) this device must accept any interference received, including interference that may cause undesired operation.

- Warning: Changes or modifications to this unit not expressly approved by the party responsible for compliance could void the user's authority to operate the equipment.
- NOTE: This equipment has been tested and found to comply with the limits for a Class B digital device, pursuant to Part 15 of the FCC Rules. These limits are designed to provide reasonable protection against harmful interference in a residential installation. This equipment generates, uses and can radiate radio frequency energy and, if not installed and used in accordance with the instructions, may cause harmful interference to radio communications. However, there is no guarantee that interference will not occur in a particular installation. If this equipment does cause harmful interference to radio or television reception, which can be determined by turning the equipment off and on, the user is encouraged to try to correct the interference by one or more of the following measures:
 - Reorient or relocate the receiving antenna.
 - Increase the separation between the equipment and receiver.
 - Connect the equipment into an outlet on a circuit different from that to which the receiver is connected.
 - Consult the dealer or an experienced radio/TV technician for help.

CAN ICES-3 (B)/NMB-3(B)

IC Statement

This device complies with Industry Canada license-exempt RSS standard(s). Operation is subject to the following two conditions: (1) this device may not cause interference, and (2) this device must accept any interference, including interference that may cause undesired operation of the device.

Le présent appareil est conforme aux CNR d'Industrie Canada applicables aux appareils radio exempts de licence. L'exploitation est autorisée aux deux conditions suivantes : (1) l'appareil ne doit pas produire de brouillage, et (2) l'utilisateur de l'appareil doit accepter tout brouillage radioélectrique subi, même si le brouillage est susceptible d'en compromettre le fonctionnement.

The device meets the exemption from the routine evaluation limits in section 2.5 of RSS 102 and compliance with RSS-102 RF exposure, users can obtain Canadian information on RF exposure and compliance.

Le dispositif rencontre l'exemption des limites courantes d'évaluation dans la section 2.5 de RSS 102 et la conformité à l'exposition de RSS-102 rf, utilisateurs peut obtenir l'information canadienne sur l'exposition et la conformité de rf.

DID: D029471

Unit doesn't respond (no power)

- Check that all connections are correct and properly plugged in.
- Make sure your device is properly paired with the iBT210.
- Make sure the Power is ON.

Unit doesn't respond (locked up or frozen)

- The unit may need to be reset. To do so, unplug the unit from power source and remove the backup batteries. Let unit stand for 2 minutes. Re-install backup batteries and connect unit to power source. You will need to reset the clock, radio, and any other settings.

Trouble pairing device/computer with iBT210

Bluetooth implementation varies depending on your device's hardware and operating system. Please see our website for updates on pairing.

- When you enter Bluetooth mode, the unit will automatically link with the last previously paired Bluetooth device if the device is still within range (about 33 feet). To pair with a different device you must enter Bluetooth mode and press the **Play/Pause Pairing Button** for 2 seconds.
- Make sure your device is working properly. Check your device's manual for details on Bluetooth pairing and linking.

For further information and to see the latest instructions, visit www.ihome.com/support

Limited 1 Year Warranty

iHome Products, a division of SDI Technologies Inc. (hereafter referred to as SDI), warrants this product to be free from defects in workmanship and materials, under normal use and conditions, for a period of one (1) year from the date of original purchase.

Should this product fail to function in a satisfactory manner, it is best to first return it to the store where it was originally purchased. Should this fail to resolve the matter and service still be required by reason of any defect or malfunction during the warranty period, SDI will repair or, at its discretion, replace this product without charge. This decision is subject to verification of the defect or malfunction upon delivery of this product to the Factory Service Center authorized by Customer Service.

If service is required, please call Customer Service at 1-800-288-2792 to obtain a Return Authorization Number and shipping instructions.

Disclaimer of Warranty

NOTE: This warranty is valid only if the product is used for the purpose for which it was designed. It does not cover (i) products which have been damaged by negligence or willful actions, misuse or accident, or which have been modified or repaired by unauthorized persons; (ii) cracked or broken cabinets, or units damaged by excessive heat; (iii) damage to digital media players, CD's or tape cassettes (if applicable); (iv) the cost of shipping this product to the Factory Service Center and its return to the owner.

This warranty is valid only in the United States of America and does not extend to owners of the product other than to the original purchaser. In no event will SDI or any of its affiliates, contractors, resellers, their officers, directors, shareholders, members or agents be liable to you or any third party for any consequential or incidental damages, any lost profits, actual, exemplary or punitive damages. (Some states do not allow limitations on implied warranties or exclusion of consequential damages, so these restrictions may not apply to you.) This warranty gives you specific legal rights, and you may also have other rights which vary from state to state.

Your acknowledgment and agreement to fully and completely abide by the above mentioned disclaimer of warranty is contractually binding to you upon your transfer of currency (money order, cashier's check, or credit card) for purchase of your SDI product.

© 2016 SDI Technologies, Inc. All rights reserved
Questions? Visit www.ihome.com
or call 1-800-288-2792 Toll Free